

The Steel Network, Inc.

StiffClip® JH

Joist Hanger

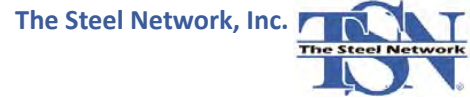

Material Composition

ASTM A1003/A1003M Structural Grade 50 (340) Type H, ST50H (ST340H): 50ksi (340MPa) minimum yield strength, 65ksi (450MPa) minimum tensile strength, with ASTM A653/A653M G90 (Z275) hot dipped galvanized coating.

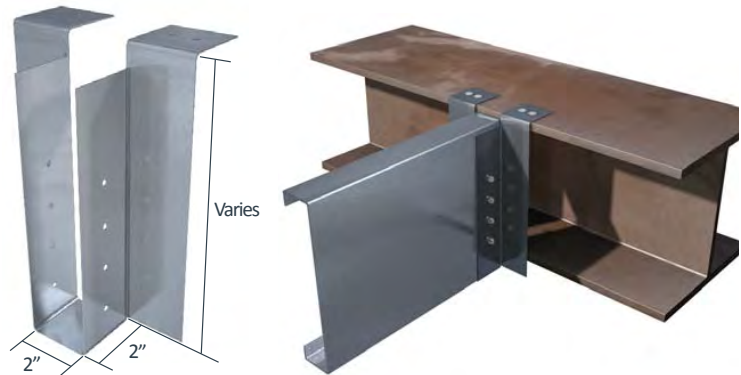

StiffClip JH Allowable Loads

StiffClip® JH Recommended Allowable Load (lbs): F3							
Joist		JH600-68	JH800-68	JH1000-68	JH1000-97	JH1200-68	JH1200-97
Thickness Mils (ga)	Yield Strength (ksi)	w/2 #12 screws	w/3 #12 screws	w/4 #12 screws	w/4 #12 screws	w/5 #12 screws	w/5 #12 screws
33 (20)	33	638	474	N/A	N/A	N/A	N/A
33 (20)	50	644	478	N/A	N/A	N/A	N/A
43 (18)	33	1,416	1,051	836	836	N/A	N/A
43 (18)	50	1,433	1,060	842	842	N/A	N/A
54 (16)	33	2,575	2,091	1,661	1,661	1,377	1,377
54 (16)	50	2,575	2,091	1,661	1,661	1,377	1,377
68 (14)	50	2,575	2,575	2,575	3,345	2,575	2,771
97 (12)	50	2,575	2,575	2,575	4,167	2,575	4,167
118 (10)	50	2,575	2,575	2,575	4,167	2,575	4,167
Max Allowable Clip Load		2,575	2,575	2,575	4,167	2,575	4,167

Notes:

- Screw size and quantity shown is required for JH to serve as web stiffener.
- Design loads based on clip capacity and allowable shear in joist. Allowable loads have not been increased for wind, seismic, or other factors.
- If beam web is larger than clip length, use blocking behind clip for support.
- StiffClip JH resists vertical loads and web crippling.
- Screws, powder-actuated fasteners, or weld attachment may be used to connect StiffClip JH to the steel header/beam. StiffClip JH 68mil and heavier can be welded to the steel beam. Powder-actuated fasteners into steel are recommended to be 0.157" diameter, and are limited to a maximum of 3/4" substrate thick.

Nomenclature

StiffClip JH is designated by listing the joist depth in inches, followed by the inside flange dimension in inches x 100 (2" flange is standard, and will also service 1 5/8" flange), and the required clip thickness in mils that will accommodate anticipated loads. (see load tables)

Example: 6" joist, 2" flange, 2,250 lbs. load
Designate: StiffClip® JH600x200-68

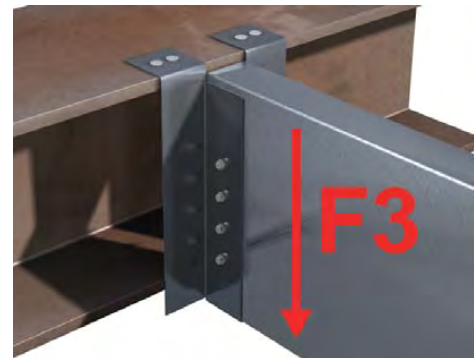

Load Direction